



SHADES
TECHNICS

1202LT TOILET CUBICLE USER MANUAL

Tel: +44(0)1992 501683 | *Cat No. 746217 – Issue 1 18/06/2009*

Contents

TITLE	PAGE
Cubicle Operating Instructions	3
Cleaning & Hygiene	5
Daily Maintenance	6
Weekly Maintenance	7
Quarterly Maintenance	7
Winterization	8
Jump Starting	8
Fault Reporting	8
Warranty Claim Procedure	9
Cubicle Spares	10
Electrical Spares	11
Interior Spares	12
Tanks & Plumbing	13
Stickers	15
PCB Overview	16
Cubicle Wiring	17
PCB Schematic	18
Fault Finding	19
Service Instructions	31

Cubicle Operating Instructions

Switching the cubicle 'ON'

Engage the WC master switch on the dashboard. The cubicle interior lamps will turn on for 60 seconds and then switch off. The cubicle is now ready to use. *(It is recommended that the vehicle engine is running).*

Interior Light

A blue LED night light will work when power is switched to the cubicle and upon entry the 2 main spot lamps will illuminate automatically. The interior lamp is controlled by a movement sensor which will switch off the light shortly after the cubicle is vacated.

To Flush The Toilet:

Push the flush button  once to flush the toilet with a set quantity of water. Should a further flush be required, wait for the flush cycle to complete then press the button again. NOTE:

(When the holding tank is full, the dashboard LED  will illuminate and the "Occupied" lamp will signal. The toilet is now out of use until the holding tank is emptied.

(When the clean water tank is empty the dashboard LED  will illuminate and the "Occupied" lamp will signal. The toilet is now out of use until the water tank is re-filled.)

To Wash Your Hands

Depress the handwash button once to dispense a set amount of water. 

(When the hand wash tank is empty the dashboard LED  will illuminate to alert the driver)

Cubicle Extractor Fan

The ventilator fan runs continuously when the master switch is ON but has the option to only work when the light is activated.

Water Tank Filling & Emptying

Tanks are filled via the hose connectors located in the side locker. Each tank also has its own drain for cleaning or winterization.

Cubicle Operating Instructions

Soil Tank Emptying

The evacuation valve on the soil tank is controlled pneumatically and can be opened via a switch in the locker, in front of the toilet, or on the dashboard.

Cleaning & Hygiene

Cubicle Cleaning

The cubicle is manufactured from Glass Reinforced Plastic (GRP) with high gloss interior and lightly textured exterior surfaces. This surface finish is delicate and must only be washed down using a mild detergent. The use of a caustic or abrasive material is not recommended, as this will affect the appearance.

Toilet Bowl Cleaning

To protect the finish of the GRP toilet bowl do not use abrasives of any kind. To clean the bowl, use a mild anti-bacterial detergent and suitable brush.

Litter Bin

The cubicle features a 35 litre plastic bin located in the locker & is filled via 2 access points. One is inside the cubicle and the other is on the top of the cubicle. The use of a bin liner is recommended.

Soap Dispenser

To fill the dispenser, lift the lid of the dispenser and fill with liquid soap.

Toilet Roll

It is recommended that a high biodegradable paper is used at all times.

Cat No. = 800103 Pack of 36.

Domestic grade toilet paper is not recommended as this can block the system.

Maintenance

Daily Routine

- Prior to the vehicle entering service the holding tank should be charged with an additive to sanitise the effluent.
- The recommended product is **Shades Super Sani ECO**, formulated from natural essential oils, this formaldehyde-free formula is contained within a water soluble membrane. A single 16 gram sachet contains the recommended dosage for 110 litre capacity holding tank and will function for a maximum of three days.
To apply:
 1. Ensure the soil tank is empty.
 2. Check the tank evacuation valve is closed
 3. Check the WC clean water tank is full.
 4. Switch on power to the cubicle (see page 3)
 5. Press the flush button and drop the complete sachet into the bowl.

Cat No. 800025 (Box 100) or Cat No. 800026 (Carton 1000)

Caution

Do not open the sachet .

- It is recommended that the WC supply tank is drained and the soil tank is emptied at the end of every day.
- The hand wash tank should be emptied and re-filled dailey. To help maintain a clean tank and freshwater the use of a sanitiser is recommended. Shades can supply a suitable product that disinfects the water, that is safe to drink and non-irritable to the skin and eyes. **Cat No. 800060**

Weekly Routine

- Check extractor fan function.
- Inspect the security of the faucet, door hinges and toilet seat. Check the operation of the cubicle door and lock function.
- Open vanity door, check electrical and plumbing connections for security and leaks.
- Check water flow to the hand basin is smooth and constant.

Quartely Routine

- Flush out soil tank with clean water. (the soil tank must be empty and the vehicle positioned so that the soil tank evacuation valve is over a sewage drainage point)

To flush out:

1. Switch on the cubicle.
2. Connect a hosepipe to a mains water supply.
3. Push a hose pipe through the flap in the bottom of the bowl and into the tank.
4. Turn on the water to the hose pipe and fill the soil tank, being careful not to overfill.
5. Switch off the water to the hose and open the evacuation valve to empty the tank.
6. Press the flush button to open the valve and remove the hosepipe.

- Lubricate soil tank evacuation valve. (to be carried out immediately after flushing through the soil tank). Undo the four fixing bolts holding the soil valve assembly together and remove the main body section. Lubricate the slide paddle using lithium grease or similar so the open/close operation is smooth. Replace the valve body and bolt together. Do not over tighten as this will restrict the operation of the valve.

- Disinfect the hand wash tanks and flush through with clean water.

Winterization

If the vehicle is to be parked in zero or sub-zero temperatures, it is imperative that all water containers are completely drained.

Note

No warranty claims will be accepted on any winter damaged parts.

Jump Starting

When jump starting the vehicle, please ensure that the dashboard master Switch for the WC is off!

Fault Reporting Procedure

1. In the unlikely event of a fault occurring an emergency parts kit has been supplied along with the enclosed comprehensive fault analysis flow chart
2. Using these charts, determine the cause of the fault and replace the faulty item from the kit if possible.
3. To order a replacement kit or non-kit part contact the dealer, quoting the cubicle serial number. The serial number is located behind the lower vanity door beneath the sink.
4. In order for replacement goods to be dispatched a simple warranty procedure must be followed.

Notes:

- **Tampering, unauthorised involvement or preventable damage will result in a charge being applied.**

Warranty Claim Procedure

Shades Technics offer a comprehensive warranty cover for all products, valid for 24 months from the vehicle's date in service.

Contact the dealer or supplier from where the vehicle was purchased.

The dealer/supplier will then contact Shades Technics who will fax a warranty claim form to the customer.

**Complete the warranty claim form, ensuring all details are filled in and fax back to Shades Technics on
+44 (0)1992 501669**

Shades Technics will dispatch any parts required or organise rectification via one of its service points.

Please return any faulty parts that have been replaced under warranty within 14 days or a charge may be applied

Spare Parts

Toilet Bowl Assy

Cat No. 688255

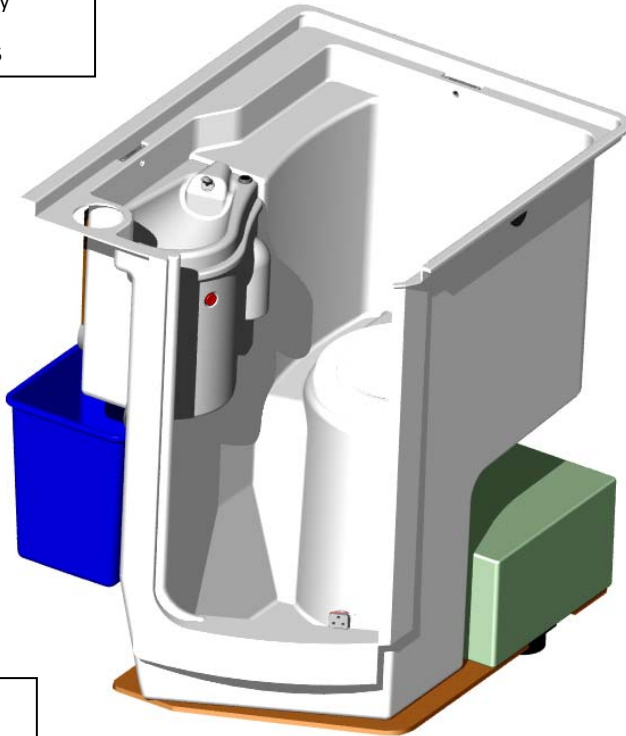

Toilet Seat

Cat No. 735101

Hinges

Cat No.735102

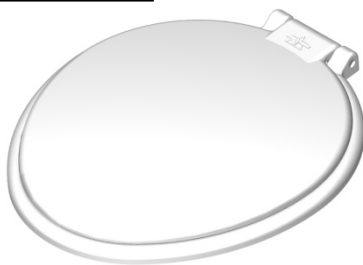

Floor Mat

Cat No. 661492

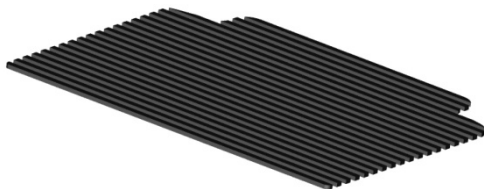

Ventilator Fan

Cat No. 727502



Ventilator Spigot

Cat No. 727503

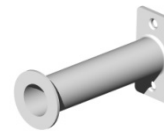
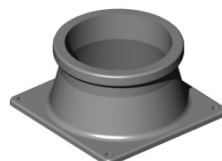

Toilet Roll Spindle

Cat No. 661624

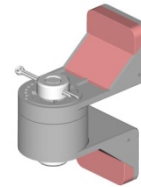

Door Hinge - Upper

Cat No. 661420

Door Hinge Lower

Cat No.661421



Vanity Screw Fixings

Cat No. 663408



Faucet

Cat No. 663609



Alarm Button

Cat No. 714030

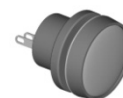

Flush / HW Button

Cat No. 714007

Spare Parts

Toilet Control PCB

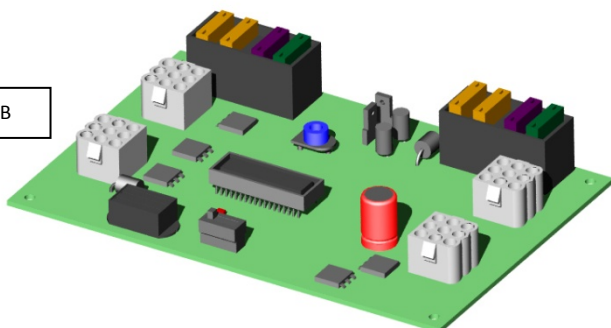

PCB

Cat No. 730638

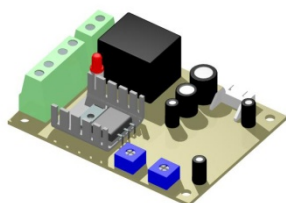

PIR PCB & Sensor

Cat No. 712080



LED Spot Light

Cat No. 712043

Spare Parts

Mirror

Cat No. 661822

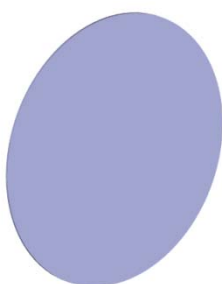

Litter Bin

Cat No. 661042

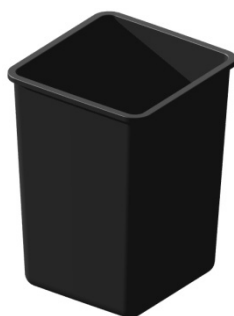

Soap Dispenser

Cat No. 661660



Bin Hinge

Cat No. 661410

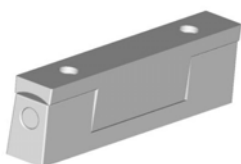

Bin Lid

Cat No. 685408

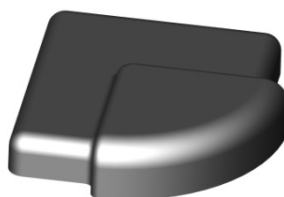

Door Lock (LH)

Cat No. 661205



Isonic Valve

Cat No. 735714



Spare Parts

HW Tank (winter kit)

Cat No. 733104

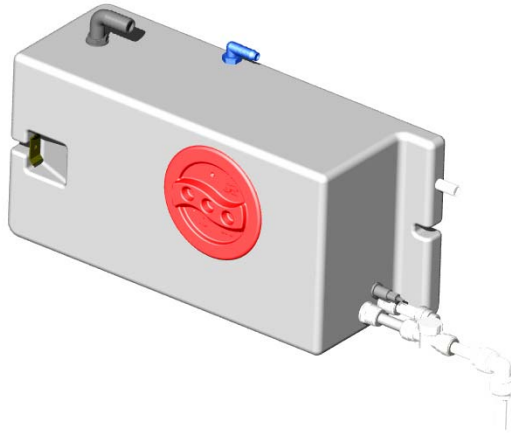

Hose Barb Filler

Cat No. 744018



Tank Coupler

Cat No. 747028

Flush Tank

Cat No. 733103

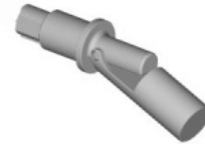
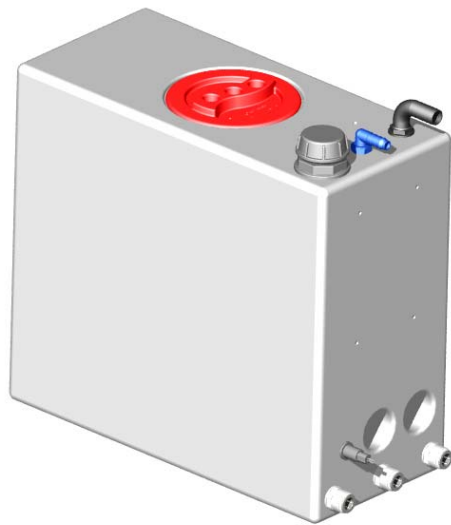

Horizontal Float Switch

Cat No. 714510



Overflow Fitting

Cat No. 744011

Soil Tank

Cat No. 733105

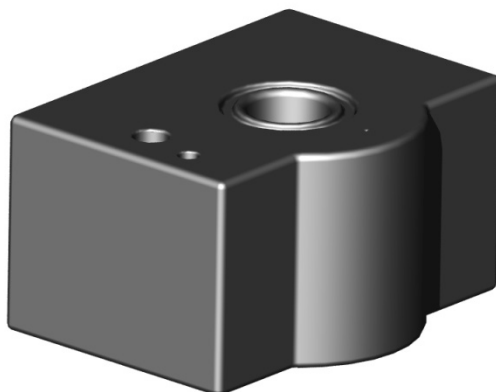

Vertical Float Switch

Cat No. 714500

Spare Parts

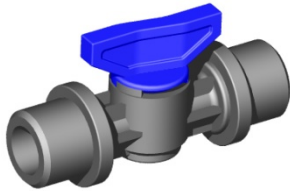

Tap

Cat No. 747044

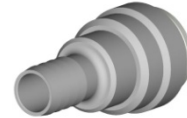

Hose Barb Connector

Cat No. 747027



HW Pump

Cat No. 702110



Tap

Cat No. 747037

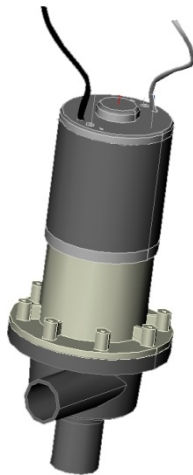

Flush Pump

Cat No. 702180

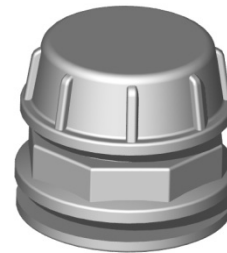

Bulkhead Cap Assy

Cat No. 732006

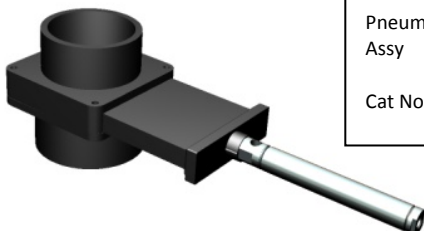
Pneumatic Dump Valve
Assy

Cat No. 735774

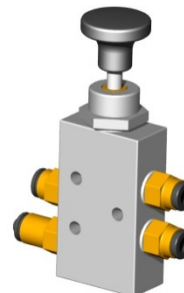

Dump Valve Pull Handle

Cat No. 735781

Spare Pull Handle

Cat No. 735781

Stickers



No Standing
Cat No:735560



Emergency Alarm
Cat No:735566



No Smoking
Cat No:735563

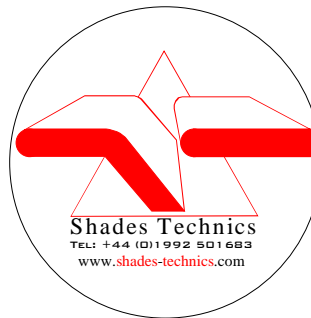

Shades Technics
Cat No:735568

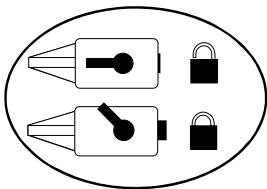

Door Lock RH
Cat No:735564

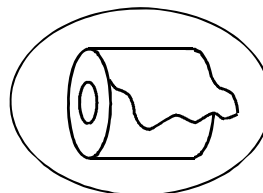

Toilet Roll
Cat No:735569

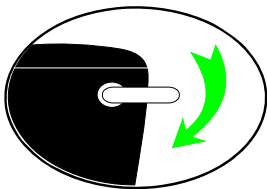

Flush
Cat No:735562

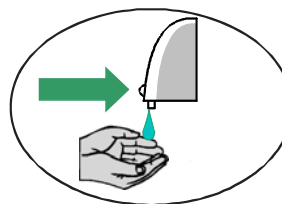

Soap Dispenser
Cat No:735572



Hand wash
Cat No:735561



Litter Bin
Cat No:735567

Full Set Of Labels
Cat No: 735570

Please specify LEFT or RIGHT hand cubicle when placing orders for labels

Toilet Control Board (PCB)

Description

The Toilet Cubicle Control Board is a solid state electronic control unit that manages all toilet cubicle functions. All output devices are short circuit and over-voltage protected for reliability and safety.

Operation

Power-up & voltage low indicator

On power-up the control board enters the shut-down mode for 60 seconds. In shut-down mode, the occupied lamp will be on and all other outputs off.

After 60 seconds, provided that the voltage is not too low, the control board will enter the normal operating mode.

If at any time the voltage drops below the threshold (set by VR1) for more than 5 seconds, the control board will re-set. After a re-set, the board starts in the shut-down mode for another 60 seconds before being fully functional.

The threshold voltage is factory set to 22V, the RED 'low voltage' LED will begin to flash if the supply drops below the threshold.

Wiring Diagram

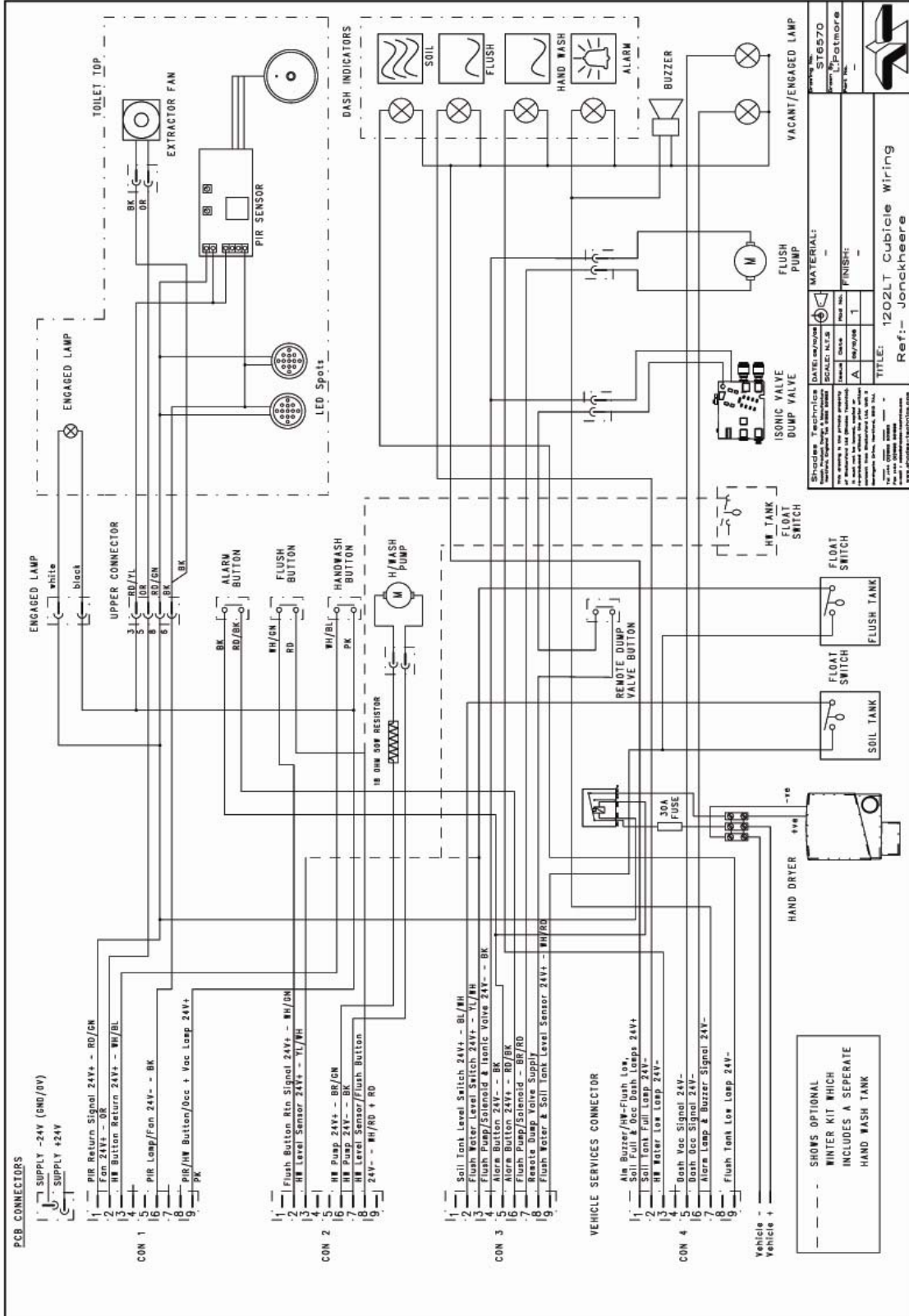

PCB Schematic

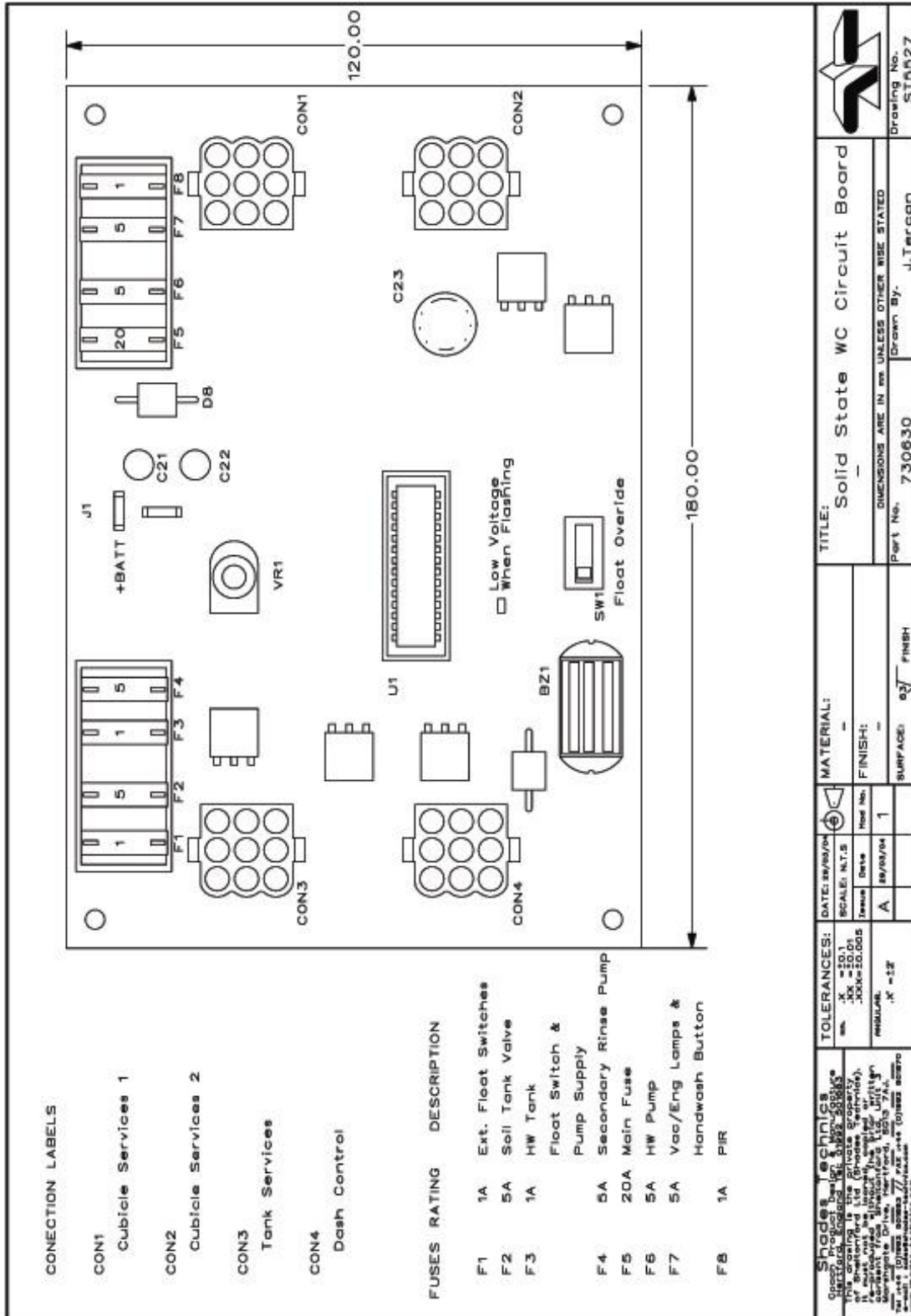

Fault Finding

1. Toilet Fails To Power Up
2. No Water From Hand Wash Faucet
3. Extractor Fan Not Functioning
4. Swing-Flush Not Working – No Water
5. Poor Water Flow Around Bowl
6. Interior Lamp Stays On Too Long/Not Long Enough
7. Aircalor Hand – Drier Not Functioning
8. Vacant/Engaged Lamp Fails
9. Interior Lamp Fails
10. Alarm Button/Buzzer Not Functioning
11. Bad Toilet Odor

Toilet Fails to Power Up

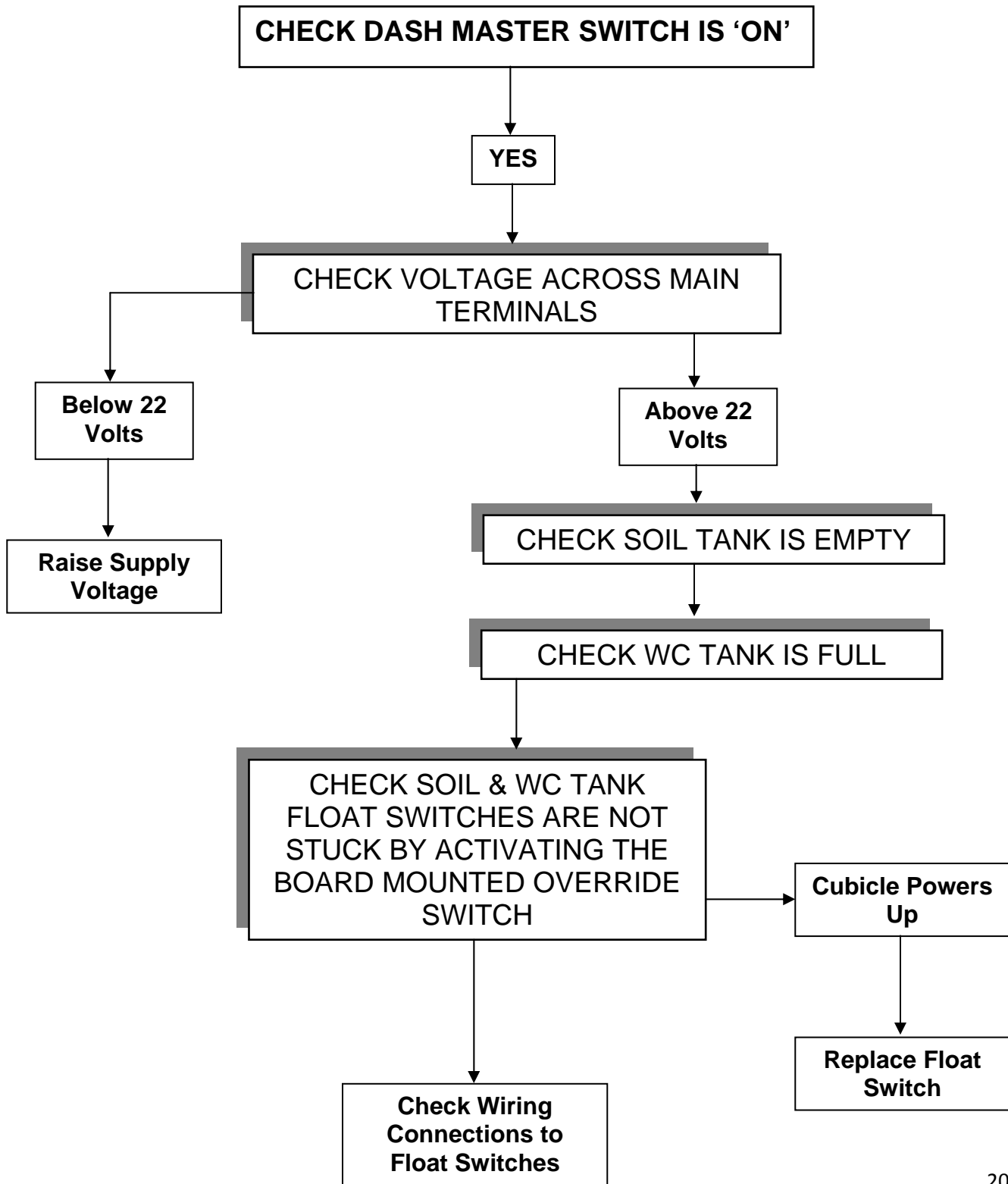

No Water from Hand Wash Faucet

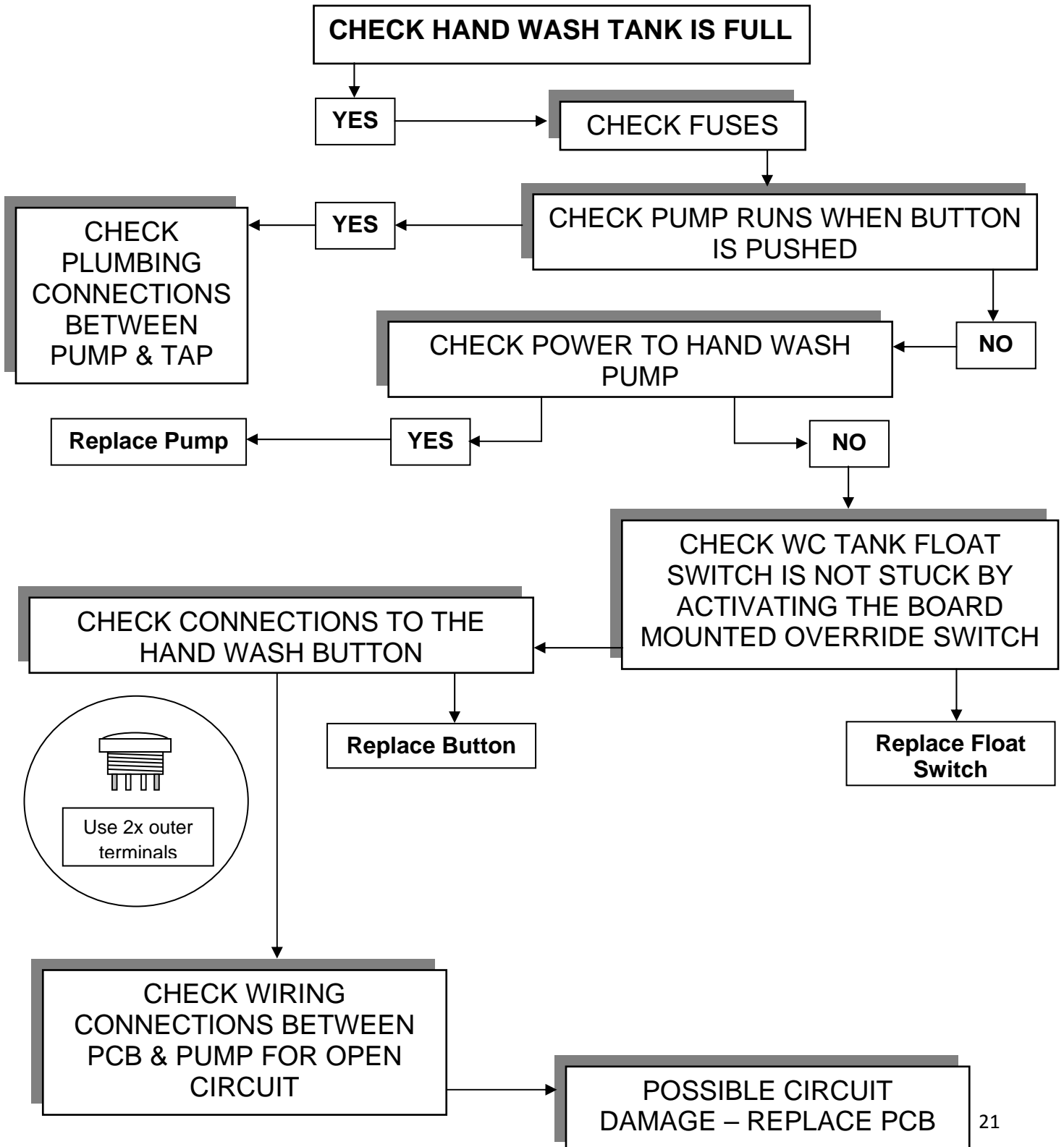

Extractor Fan not Functioning

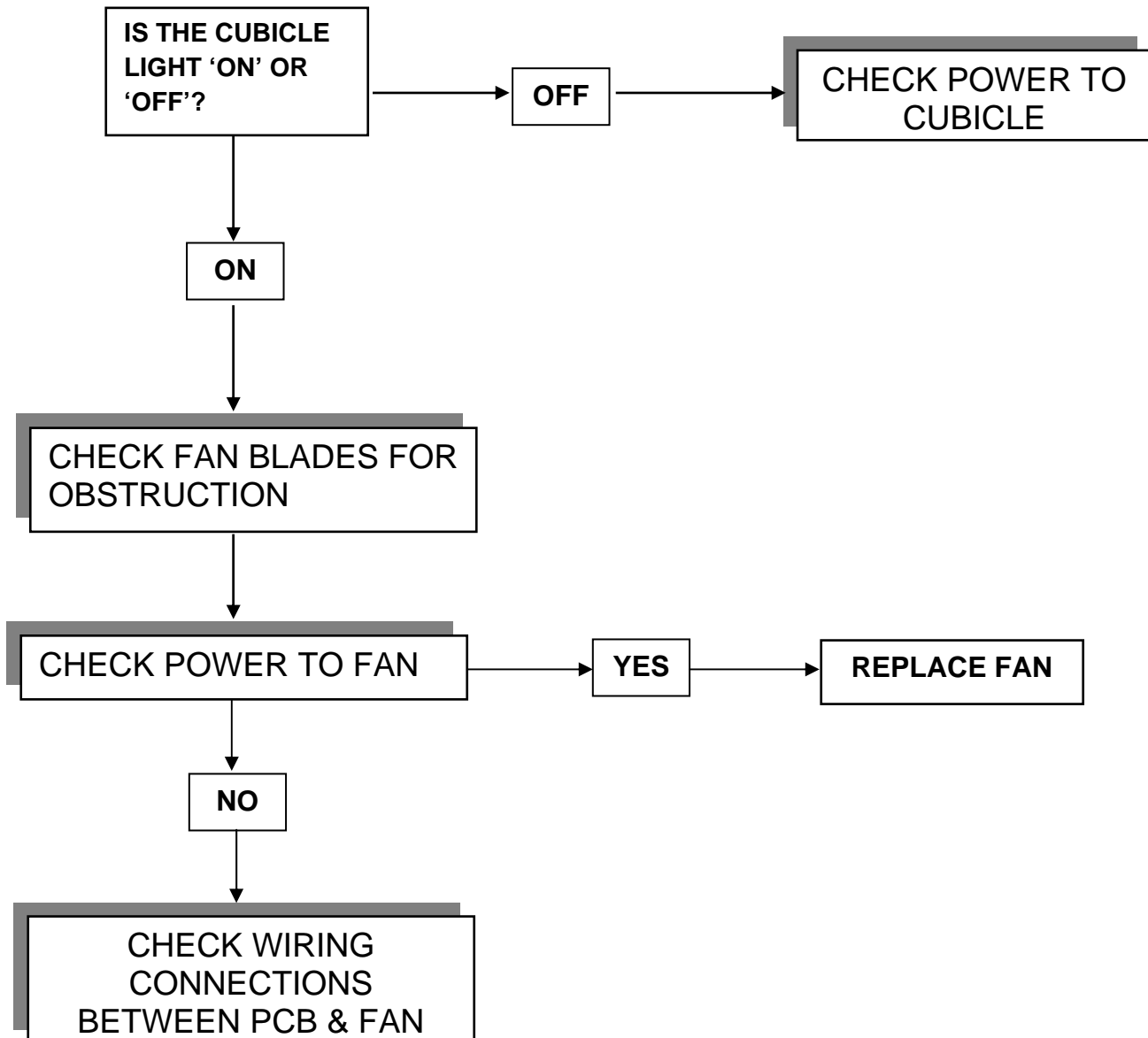

Swing-Flush not Working – No water

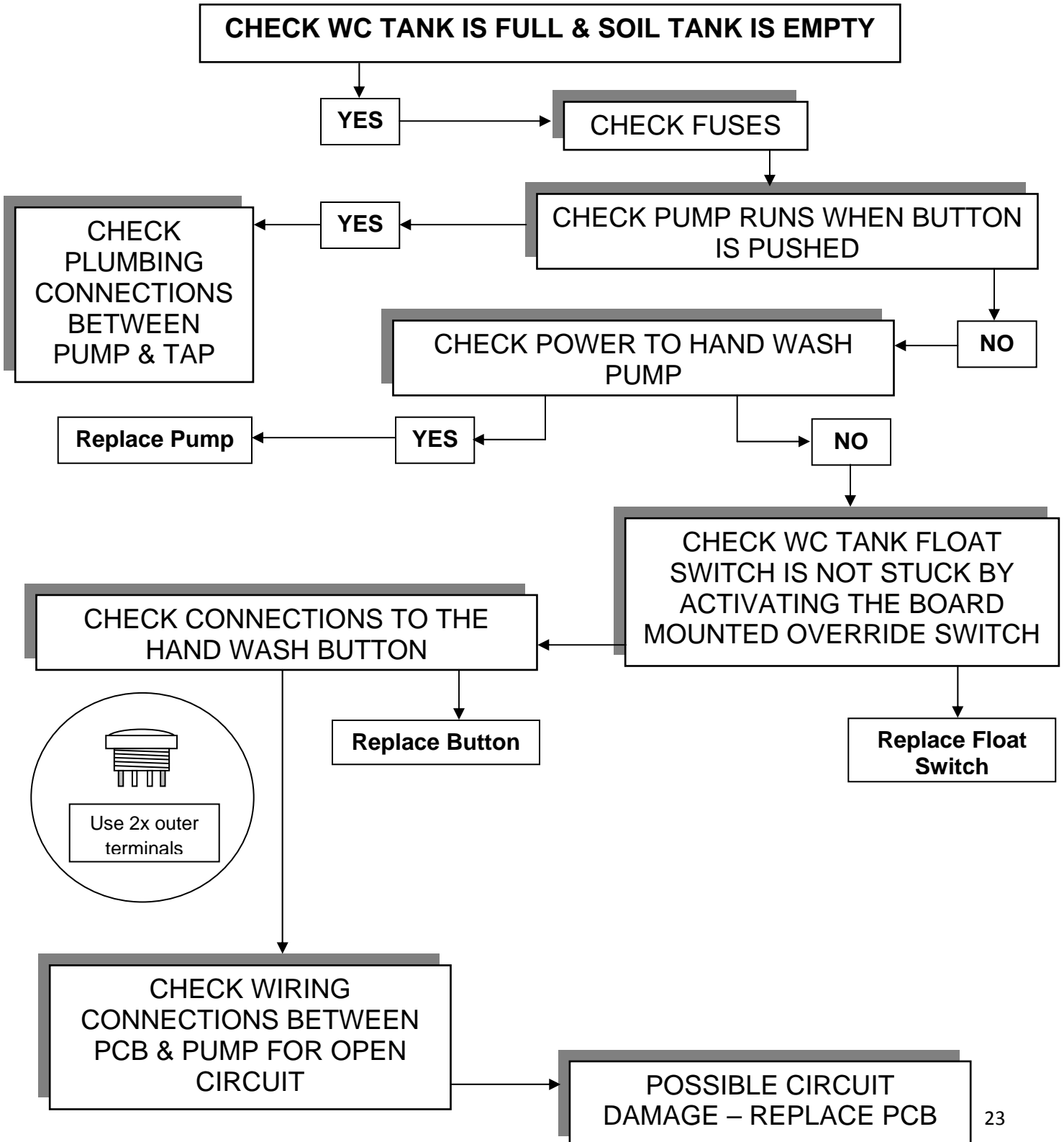

Poor water Flow around Bowl

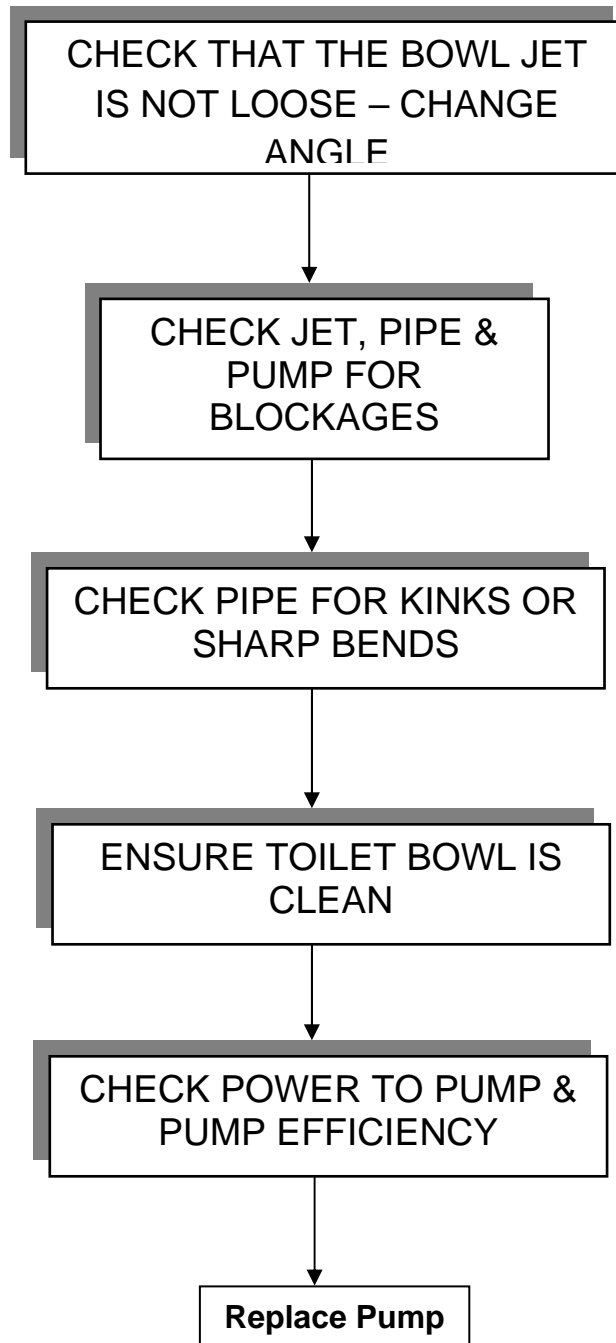

Interior Lamp Stays ON Too Long/Not Enough

THE INTERIOR LAMP SENSOR DETECTS BOTH HEAT & MOVEMENT. IT IS PRE-SET TO TURN OFF THE INTERIOR LAMPS 30 SECONDS FROM ITS LAST DETECTION

TO EXTEND THE TIME

TURN RIGHT ADJUSTER
CLOCKWISE

TO REDUCE THE TIME

TURN RIGHT ADJUSTER
ANTI-CLOCKWISE

IF ADJUSTMENT DOES
NOT ALTER THE TIME –
REPLACE PIR PCB &
SENSOR

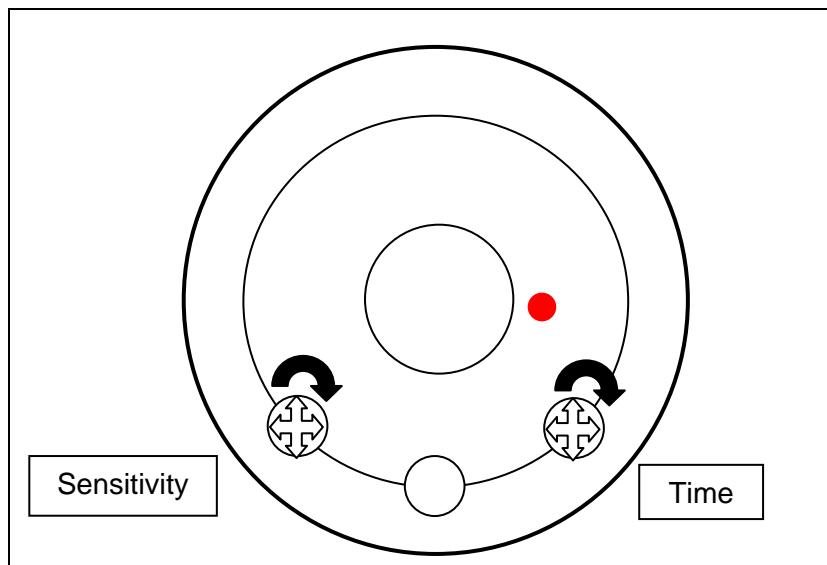

THE LEFT HAND ADJUSTER ALTERS THE SENSITIVITY OF THE
SENSOR – CLOCKWISE TO INCREASE

Hand-Drier Not Functioning

The Aircalor Hand-Drier will only Function with the WC Master Switch On and the Cubicle Interior Light On.

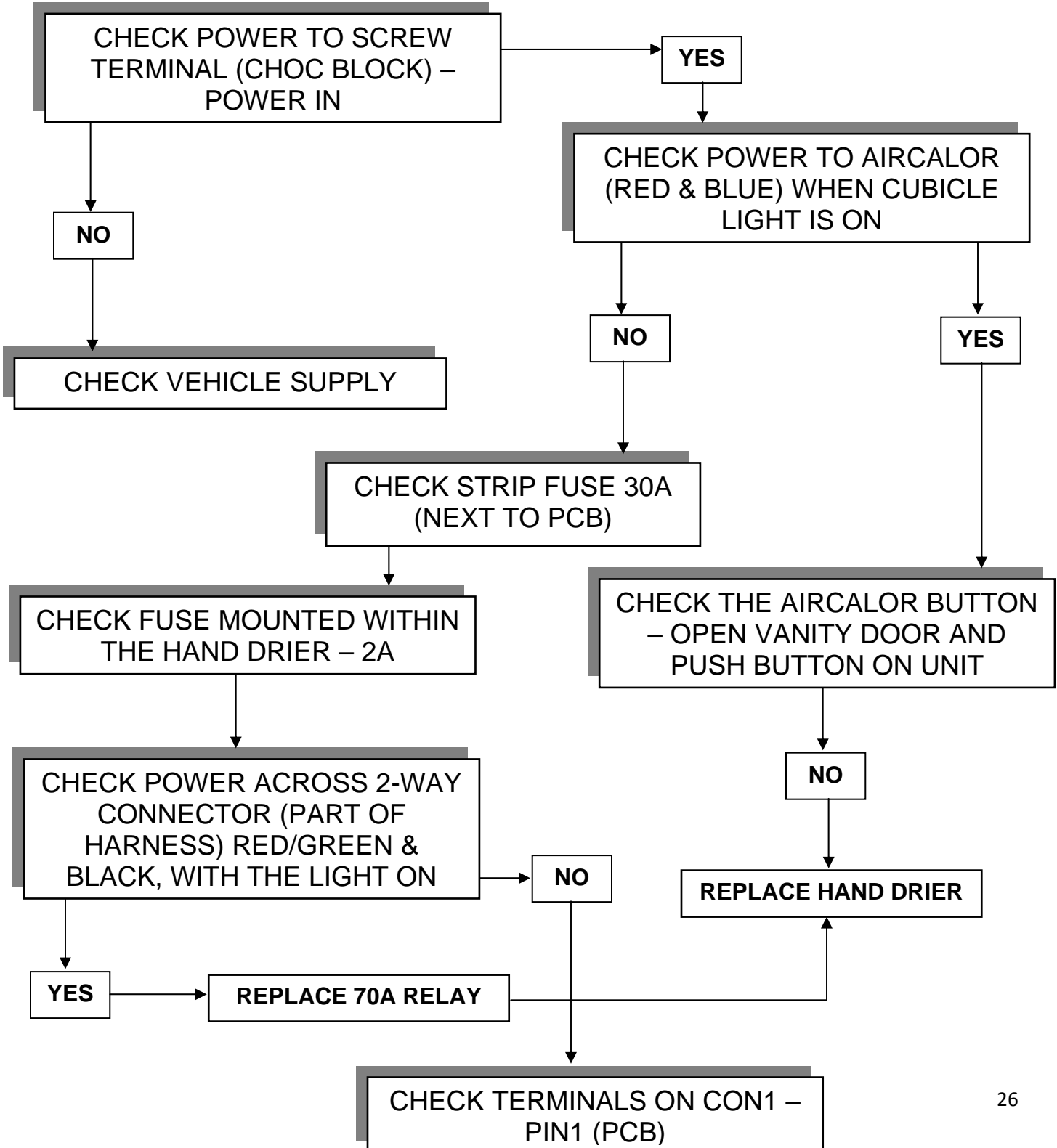

Vacant/Engaged Lamp Fails

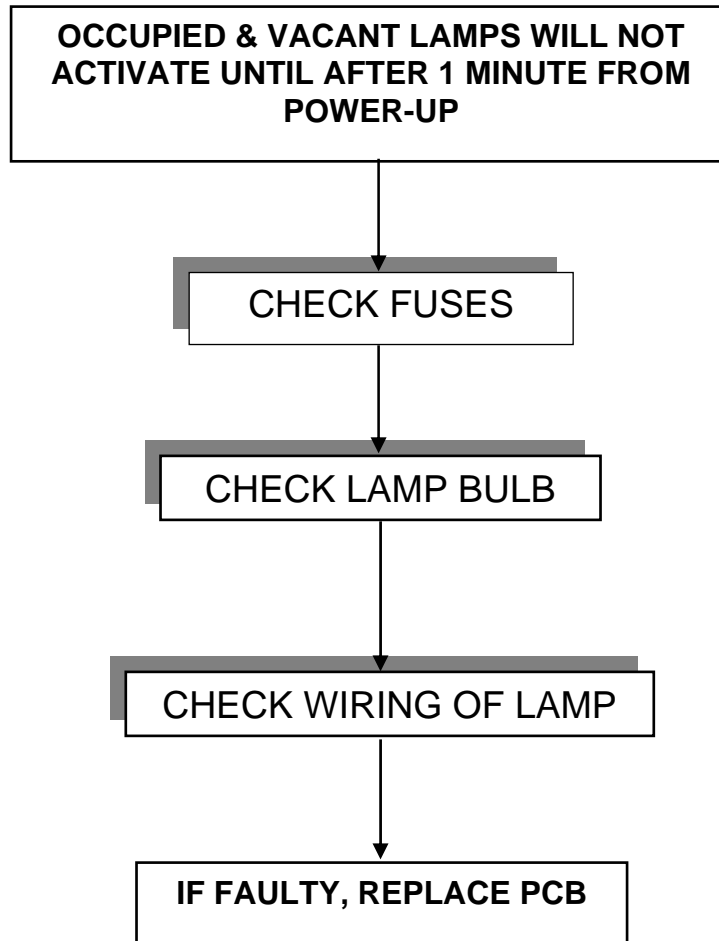

Interior Lamps Fail

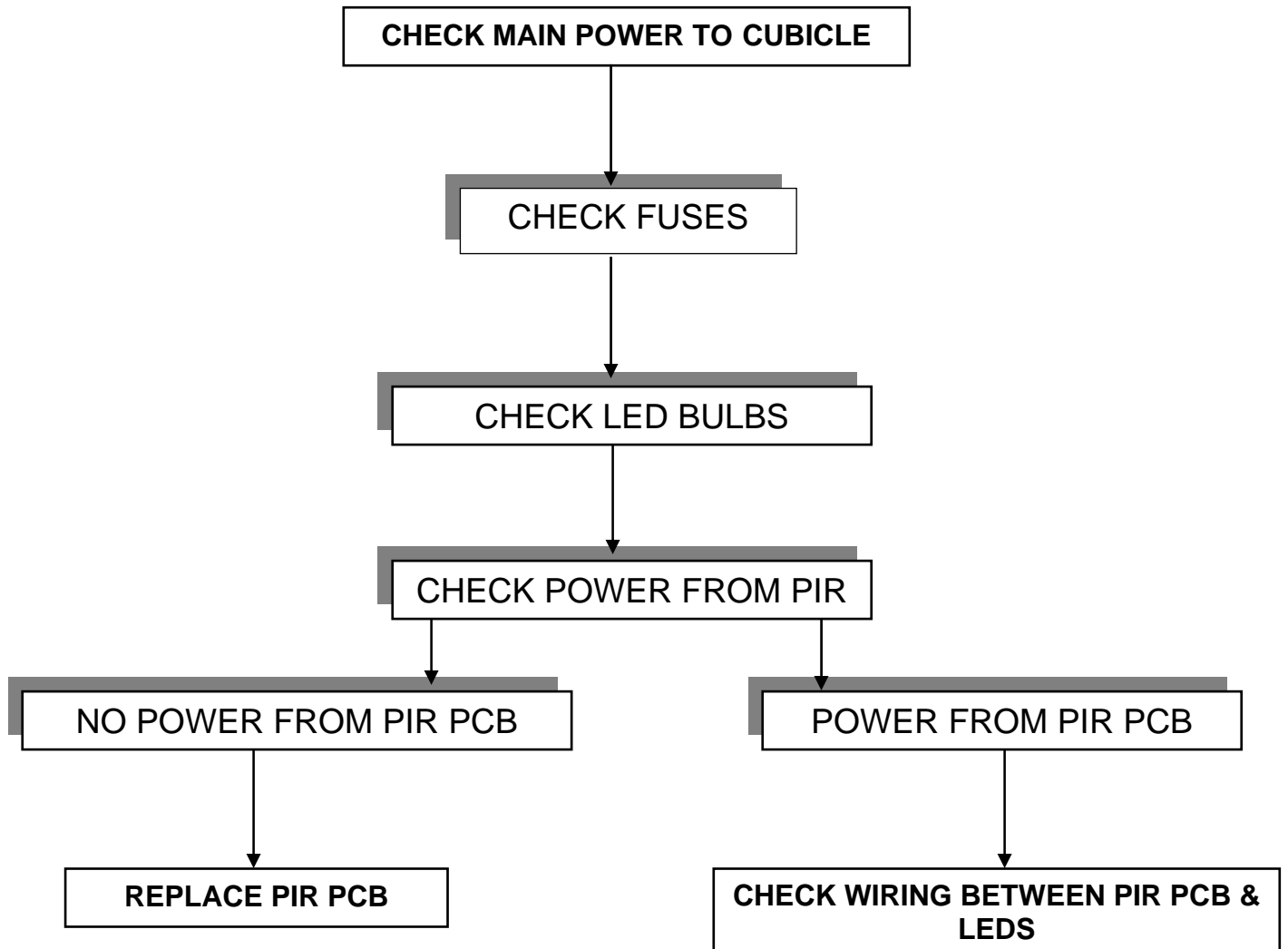

Alarm Button/Buzzer Not Functioning

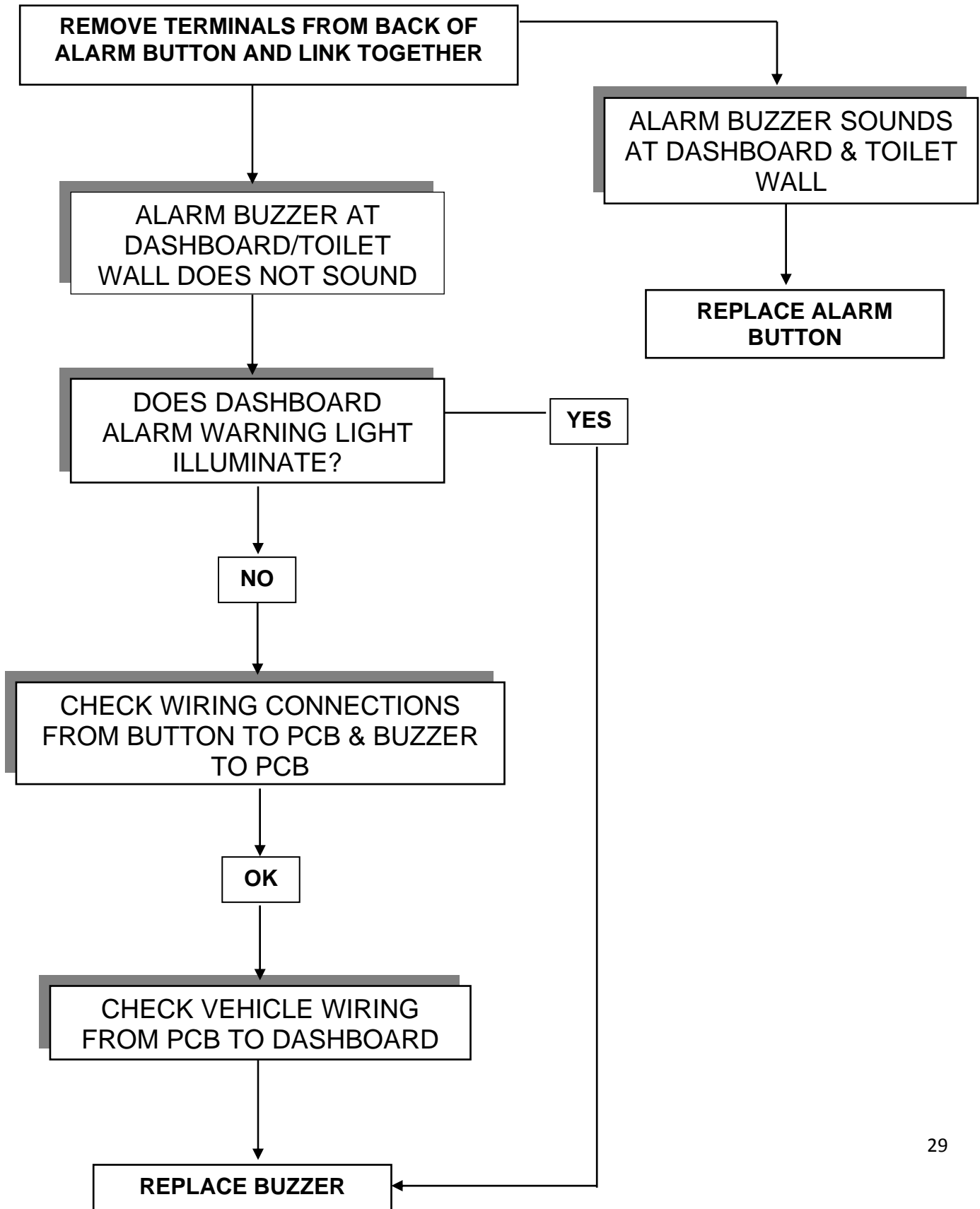

Bad Toilet Odor

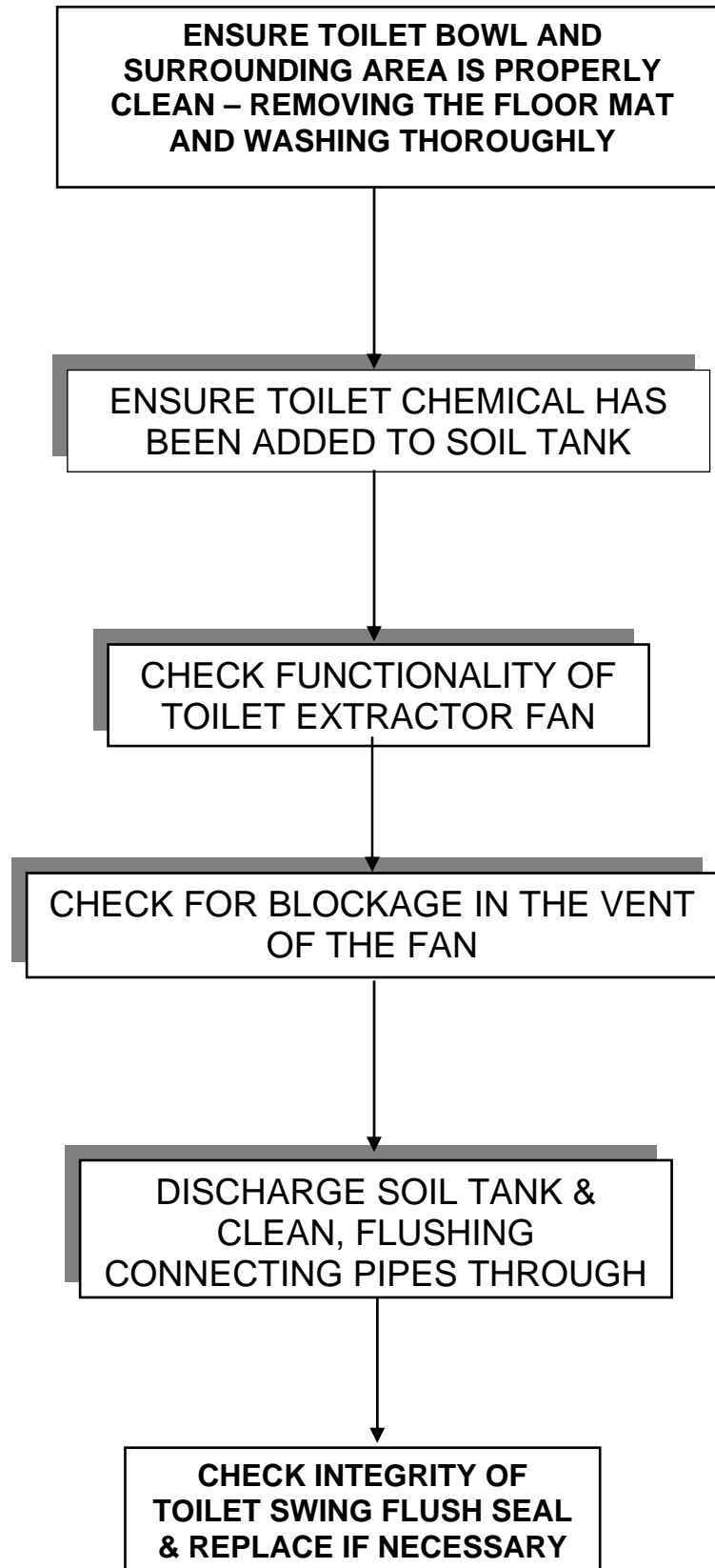

Service

The following section details where to find key components and how to replace them.

Part = Lights

Location = Cubicle Ceiling Panel

Replacement....

DISCONNECT THE POWER TO THE CUBICLE

GENTLY PULL THE LED LAMP FROM THE CEILING LIFTING THE EDGES WITH A FLAT SCREW DRIVER. USE MASKING TAPE TO PROTECT THE GRP CEILING PANEL FROM THE BLADE.

DISCONNECT THE LIGHT UNIT & REPLACE

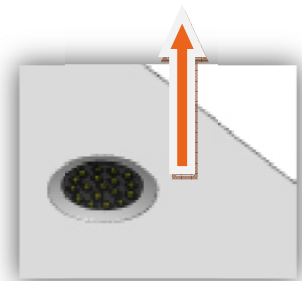

Part = PIR Sensor

Location = Cubicle Ceiling Panel

Replacement....

REMOVE 3x SCREWS SECURING THE PIR COVER

TAKE OUT THE PIR SENSOR AND UNCLIP THE CABLE

RE-FIT A NEW SENSOR & CHECK THE SENSITIVITY AND TIMING ADJUSTMENT IS CORRECT

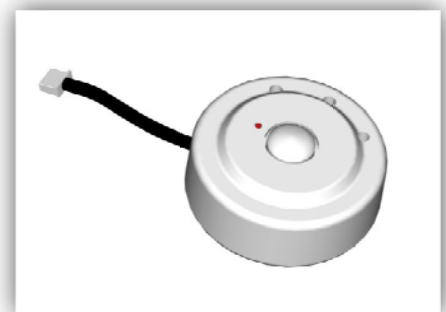

Service

Part = Hand Drier

Location = Cubicle Wall

Replacement....

DISCONNECT THE POWER TO THE CUBICLE

REMOVE 2x SCREWS ON THE UNDERSIDE OF THE HAND DRIER

REMOVE THE FRONT COVER OF THE HAND DRIER

REMOVE 2x RUBBER HOLE COVERS

REMOVE 3x SCREWS RELEASING THE UNIT FROM THE WALL

DISCONNECT THE 2 CABLES PASSING THROUGH THE OUTER WALL OF THE CUBICLE MAKING SURE THEY DO NOT FALL DOWN THE BACK

RE-CONNECT A NEW UNIT AND SCREW TO THE WALL

MAKE SURE THE RUBBER HOLE COVERS ARE RE-FITTED AND FIT THE COVER SECURING WITH BOTH SCREWS

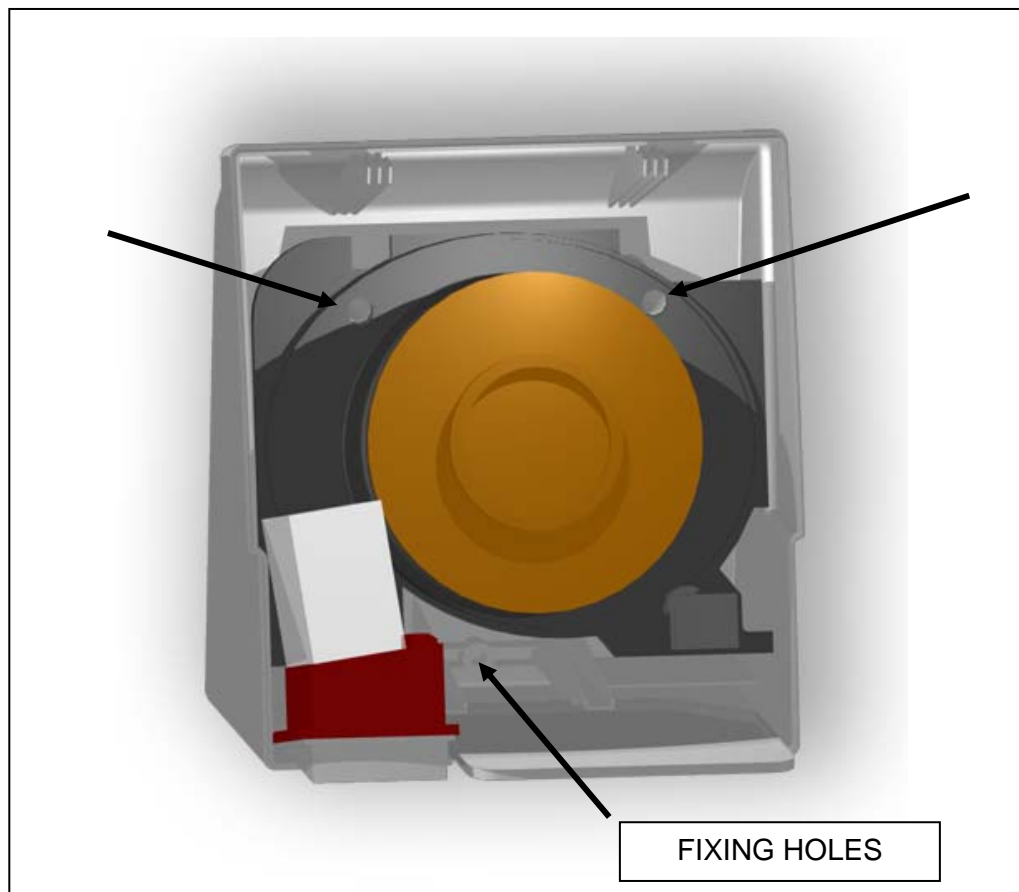

Service

Part = Hand Wash & Flush Buttons

Location = Sink Vanity

Replacement....

DISCONNECT THE POWER TO THE CUBICLE

UNSCREW THE BUTTON HOLDER COVER

REMOVE TERMINALS FROM THE BACK OF THE BUTTON

UNSCREW THE COLLAR ON THE UNDERSIDE OF THE BUTTON

BUTTON SHOULD RELEASE FROM THE TOP

RE-FIT NEW BUTTON AND CONNECT THE TERMINALS

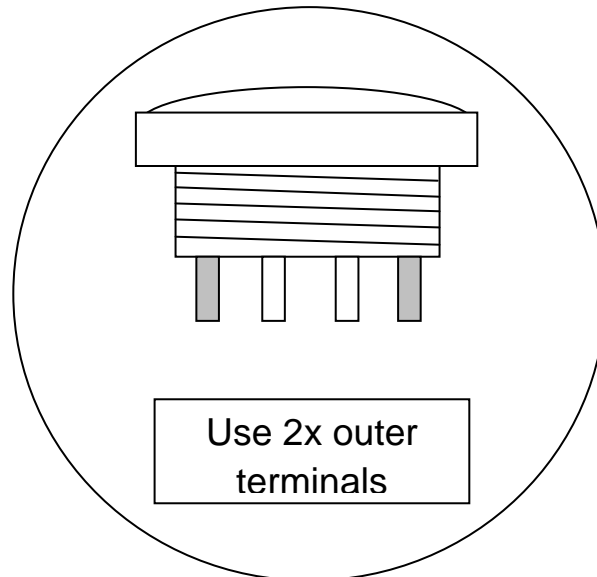

Service

Part = Hand Wash & Flush Pump

Location = Hand Wash Pump = Locker above nearside wheel arch – Supply Tank = Between the rear, nearside, wheels.

Replacement....

DISCONNECT THE POWER TO THE CUBICLE

REMOVE ANY ACCESS PANELS PROTECTING THE TANKS

DRAIN FRESHWATER TANK

DISCONNECT THE WIRES TO THE PUMP

REMOVE FROM SECURING CLIP

RELEASE INLET AND OUTLET PIPES

RE-FIT NEW PUMP MAKING SURE THAT BOTH INLET AND OUTLETS ARE WATER TIGHT AND THE FLOW ARROW IS POINTING IN THE CORRECT DIRECTION

RE-CONNECT THE POWER

CLOSE THE DRAIN ON THE SUPPLY TANK

RE-FILL TANK WITH FRESHWATER

SWITCH ON POWER TO CUBICLE

PRIME PUMP WITH 2-3 BUTTON PUSHES

WIRING CONNECTIONS

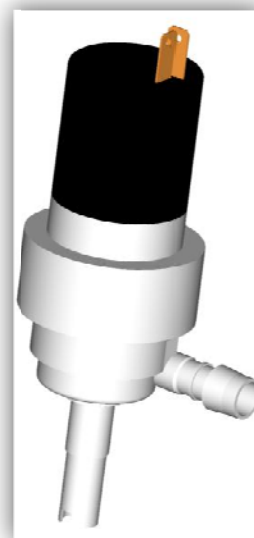

OUTLET

INLET

Service

Part = PCB

Location = LH-Side of toilet door below a floor hatch.

Replacement....

LIFT FLOOR ACCESS TRAP

FOLD BACK THE PLASTIC SPLASH COVER PROTECTING THE PCB

DISCONNECT THE POWER TO THE CUBICLE BY REMOVING THE 2-WAY CONNECTOR

REMOVE ALL FOUR REMAINING 9-WAY CONNECTORS

REMOVE THE 4X SCREWS HOLDING THE PCB

FIT THE NEW PCB & ATTACH THE FIVE CONNECTORS MAKING SURE THAT THE FOUR 9-WAYS GO BACK IN THE CORRECT ORDER.

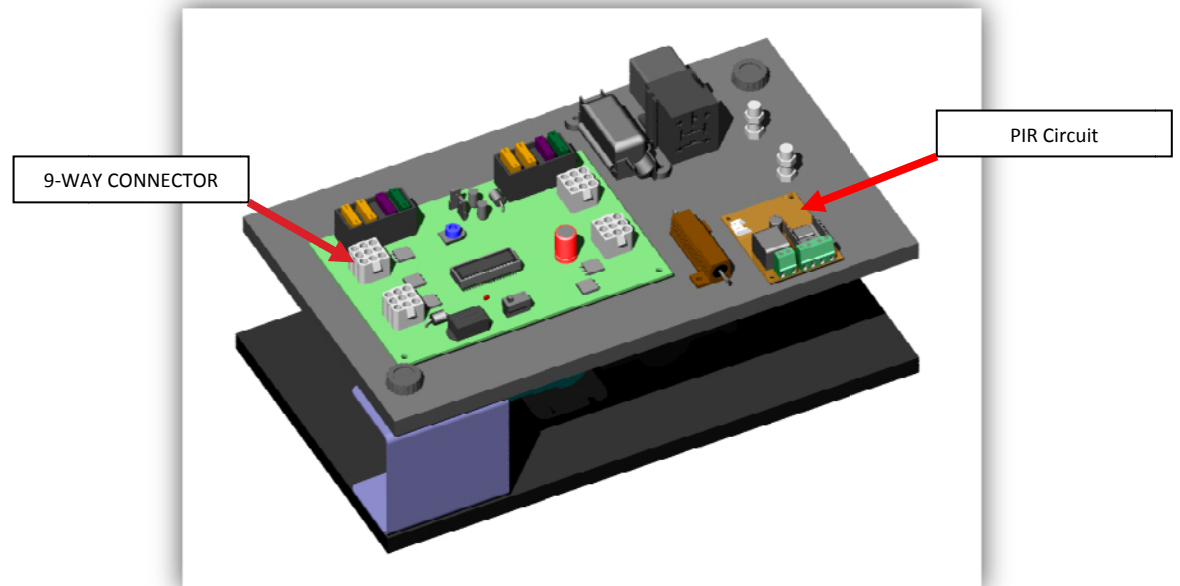

Part = PIR Circuit Board

Location = LH-Side of toilet door below a floor hatch. (next to the main PCB)

Replacement....

LIFT FLOOR ACCESS TRAP

FOLD BACK THE PLASTIC SPLASH COVER PROTECTING THE PCB

DISCONNECT THE POWER TO THE CUBICLE BY REMOVING THE 2-WAY CONNECTOR

REMOVE ALL WIRES IN THE SCREW TERMINALS & THE SMALL SENSOR PLUG

REMOVE THE 2X SCREWS HOLDING THE PCB

FIT THE NEW PCB & ATTACH THE SMALL PLUG & WIRES MAKING SURE THAT THE WIRES GO BACK IN THE CORRECT ORDER.